

PROSCAN

LED TV

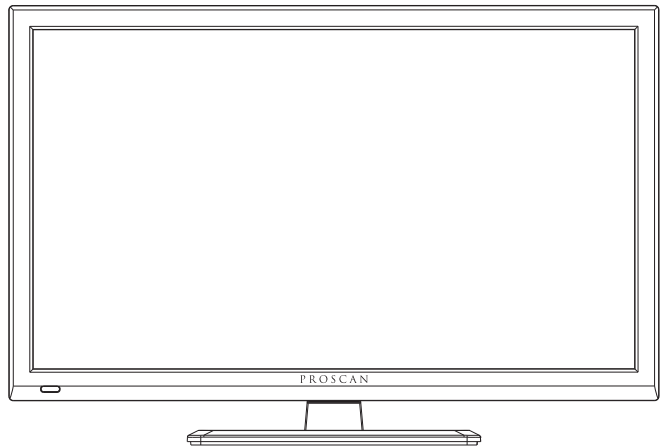

PLEDV2488A



IMPORTANT

Please read this manual carefully before installing and operating the TV
Keep this manual handy for further reference

Table of Contents

Caution	2
Important Safety Precautions	3
Wall Mount In Stallation	4
TV Bracket assembly	5
Top/Side panel diagram	6-7
Remote Controller	8
Battery Installation	
Using the Remote Control	
Install TV	9
Set your TV	
Connect Antenna and power	
Turn On TV	
Systems Connection	10
Select Input Source	12
Main Menu Operation	13-29
Picture Menu	13-15
Audio Menu	16-17
Channel Menu	18-20
Parental Menu	21-25
Setup Menu	26-29
DVD Setup	30-31
Help	32
Specifications	33

Caution



The lightning flash with arrowhead symbol, within an equilateral triangle is intended to alert the user to the presence of un-insulated "dangerous voltage" within the products enclosure that may be of sufficient magnitude to constitute a risk of electric shock to the persons.



The exclamation point within an equilateral triangle is intend to alert the user to the presence of important operating and maintenance (servicing) instructions in the literature accompanying the appliance.



Correct disposal of this Product

Waste Electrical & Electronic Equipment (WEEE)

Your product is designed and manufactured with high quality materials and components which can be recycled and reused.

This symbol means that electrical and electronic equipment, at their end-of-life, should be disposed of separately from your household waste.

Please dispose of this equipment at your local community waste collection/recycling centre.

In the European Union there are separate collection systems for used electrical and electronic products. Please help us to conserve the environment we live in!

Important Safety Precautions

- 1) Read these instructions.
- 2) Keep these instructions.
- 3) Heed all warnings.
- 4) Follow all instructions.
- 5) Do not use this apparatus near water.
- 6) Clean only with dry cloth.
- 7) Do not block any ventilation openings. Install in accordance with the manufacturer's instructions.
- 8) Do not install near any heat sources such as radiators, heat registers, stoves, or other apparatus (including amplifiers) that produce heat.
- 9) Do not defeat the safety purpose of the polarized or grounding-type plug. A polarized plug has two blades with one wider than the other. A grounding type plug has two blades and a third grounding prong. The wide blade or the third prong are provided for your safety, If the provided plug does not fit into your outlet, consult an electrician for replacement of the obsolete outlet.
- 10) Protect the power cord from being walked on or pinched particularly at Plugs, convenience receptacles, and the point where they exit from the apparatus.
- 11) Only use attachments /accessories specified by the manufacturer.
- 12) Use only with the cart, stand, tripod, bracket, or table specified by the manufacturer, or sold with the apparatus. When a cart is used caution when moving the cart/apparatus combination to avoid injury tip-over.



- 13) Unplug this apparatus during lightning storms or when unused for long periods of time.

Caution:

- 14) To reduce the risk of fire or electric shock, do not expose this apparatus to rain or moisture.
- 15) The apparatus shall be disconnected from the mains by placing the power/standby switch in the standby position and unplugging the power cord of the apparatus from the AC mains receptacle.
- 16) The socket-out shall be installed near the equipment and shall be easily accessible.
- 17) This product should never be placed in a built-in installation such as a bookcase or rack unless proper ventilation is provided or the manufacture's instructions have been adhered to.
- 18) The apparatus shall not be exposed to dripping or splashing and that no objects filled with liquid, such as vases, shall be placed on the apparatus.
- 19) Do not place any sources of danger on the apparatus (e.g. liquid filled objects, lighted candles).
- 20) Wall or Ceiling Mounting - The appliance should be mounted to a wall or ceiling only as recommended by the manufacturer.
- 21)  Never place the TV, remote control or batteries near naked flames or other heat sources, including direct sunlight. To prevent the spread of fire, keep candles or other flames away from the TV, remote control and batteries at all times.
- 22) The USB terminal should be loaded with 0.5 A under normal operation.

These servicing instructions are for use by qualified service personnel only. To reduce the risk of electric shock do not perform any servicing other than that contained in the operating instructions, unless you are qualified to do so.

Wall Mount Installation

INSTALLING / REMOVING THE BASE STAND

WARNING : The TV Display is very fragile and must be protected at all times when removing the base Stand.

Be sure that no hard or sharp object or anything that could scratch or damage the TV display comes into contact with it. Do NOT exert pressure on the front of the unit at any time because the screen could crack.

1. Disconnect all cables or cords connected to the unit.
2. Lay the unit down on a flat surface with the back side facing up. Please make sure to place a soft cushioned material (such as a pillow or thick piece of foam) beneath the screen.
3. To remove the base stand, loosen screws off the holes then pull downwards to release the base stand.

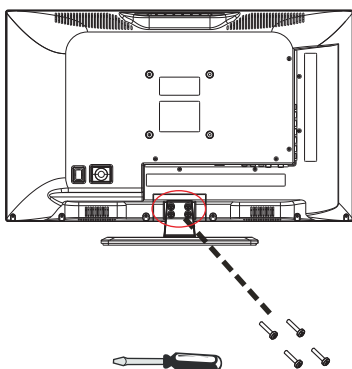

MOUNTING ON THE WALL

This unit is VESA-compliant, and is designed to be wall-mounted with a VESA-compliant 3.95" x 3.95" (100mm x 100mm) mounting kit designed for flat-panel TVs (not supplied). Mount this unit according to the instructions included in the mounting kit. Length of screw should not exceed 8 mm.

NOTE

Remove the base stand before mounting the unit on the wall.

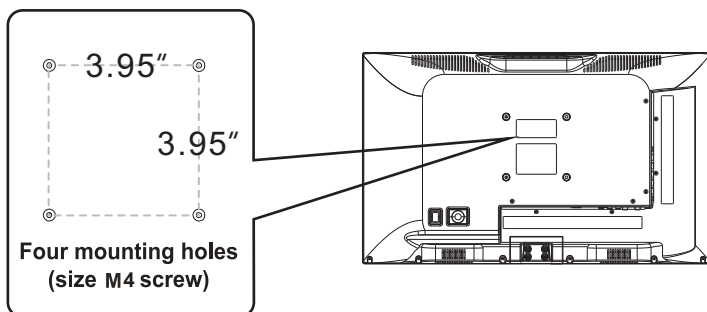

TV Bracket assembly

1. Match the TV unit into the stand, then hold the TV stand, revolve and lock the tv unit tightly as the arrowhead point.

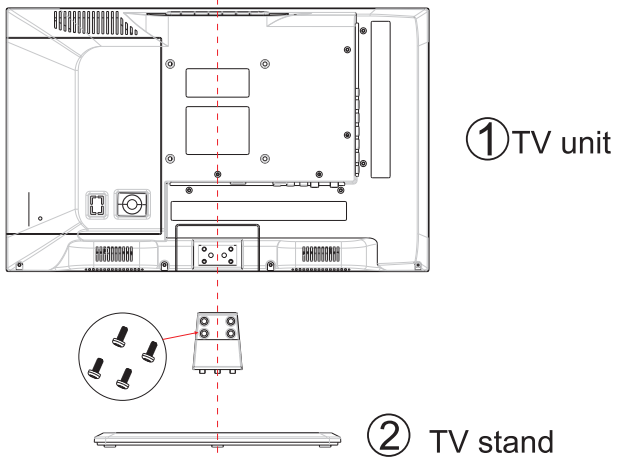

2. Fix the screws into the TV stand after installing the tv unit and tv stand.

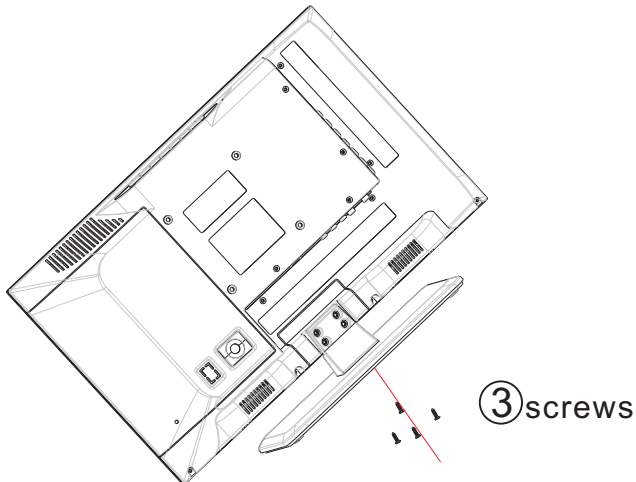

Top panel diagram

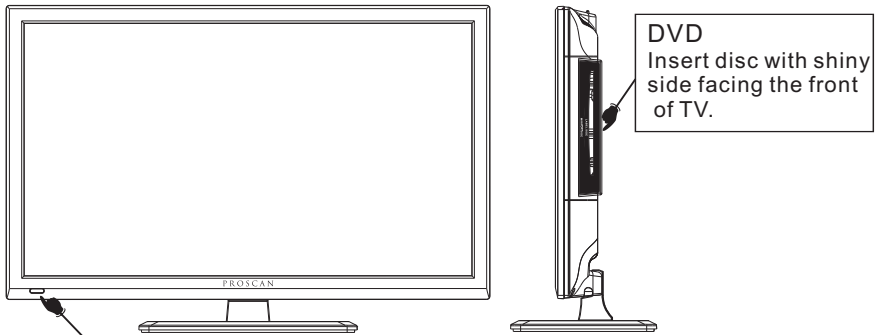

(IR) Infrared Receiver: Receives IR signals from the remote control.
(Power on/Standby) LED Indicator: Press to turn on and off

Indicator on(Red)

Standby mode

Indicator on(Green)

Power on mode

The effective receiving scope for the signal is 5-8 meters from the front of the remote control window, and 30° to the left or right side and 20° above or below the control window.

- The functions of the buttons on the TV are as follows:

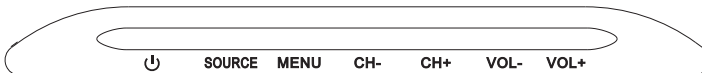

VOL+/-: Press to adjust the volume.

CH+/-:When watching TV: select channels.

MENU:

- 1.Press Menu.
- 2.Press SOURCE to enter.
- 3.Use CH+/- to shift UP/DOWN.
- 4.Press SOURCE to confirm, then press VOL+/-to adjust.
- 5.Press SOURCE to confirm

SOURCE: External signal input selection and confirm the item selected.

⏻ : Turn on/standby the TV set.

Side Panel Diagram

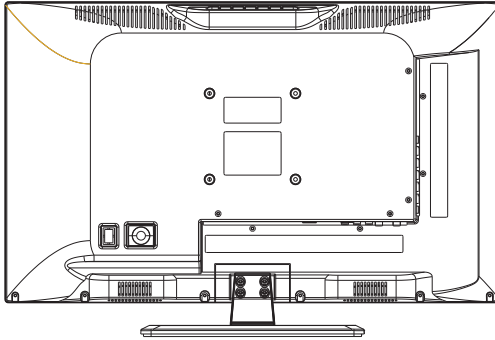

(Left Side)



(Back Side)

Name	Function Description
COAXIAL	Digital Audio Output
AV INPUT	External AV signal input and relevant right/left sound channel
EARPHONE	Earphone output
VGA IN	VGA signal from computer output
PC AUDIO IN	PC audio input
ANT 75Ω	Connect to ANT or cable source
HDMI IN	Connect to HDMI of DVD or other equipment
Service Port	For Upgrade Use
YPbPr	Connect to the composite terminal of your DVD/VCR

Remote Controller

SLEEP: Select amount of time before TV turn off automatically.
S.MODE: Press to cycle through the different sound settings
P.MODE: Press to cycle through the different picture settings

THUMBSTICK (▲▼◀▶):
 Allows you to navigate the on-screen menus and adjust the system settings to your preference.

MTS / MP3PROG:
 Press to select the audio mode, you can select stereo, Mono, or SA (second audio program). When playing mp3 disc, press MP3 PROG two times to see the favorite music to playlist, press PROG two times to see the Electronic Program Guide.
EPG: Launches the EPG (Electronic Program Guide)
D.Setup: DVD system setup.
CH +/-: Press to scan through or to select a channel.
V +/-: Press to increase / decrease the sound level.

FAV
 Set or cancel current channel to be a favourite channel.
FAV- Down movie Favourite program
FAV+ Up movie Favourite program
 DVD eject
 Play/Pause DVD program.
 Stop DVD program.

D.MENU: DVD disc menu, press this to access the menu.
D.TITLE: Press to select the DVD title.
GO TO: Play your favorite title/chapter/track.
D.DISP: Press to display the source and channel's info.
PROG
 Press this button to change the playback order. It varies according to the different discs.
STEP: Play for single frame image
REPEAT Repeat playing the title or chapter.
A-B During the playback, press this button to repeat playback of a specific section on a disc.

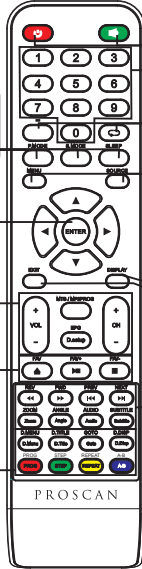

POWER
 Set your TV to power on or standby mode.
MUTE
 Press to mute the sound. Press again or press VOL+ to unmute.

NUMBER BUTTONS
 Press 0-9 to select a TV channel directly when you are watching TV. The channel change after 2 seconds.
 Press "*" to enter a program number for multiple program channel, such as 2-1 etc.
 Return to the previous channel viewed.

MENU
 Allows you to navigate the on-screen menus.
SOURCE
 Press to cycle through the input source in following:
 TV → AV → DVD → YPBPR → HDMI1 → HDMI2 → PC

DISPLAY
 Press to display the source and channel's information.
EXIT
 Exit from the menu or sub-menu and cancel the function in progress (if applicable)

DVD next chapter.
 DVD previous chapter.
 DVD fast reverse.
 DVD fast forward.
 ZOOM In DVD source adjust DVD picture size
ANGLE Select DVD picture angle.
AUDIO Select DVD disc language.
SUBTITLE Select DVD disc subtitle.

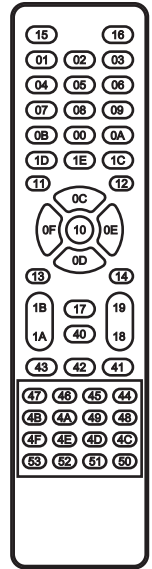

Universal remote code
 This is the code for remote control of PLEDV2488A, if you want to change to a universal remote control, you can edit this code into your universal remote control.

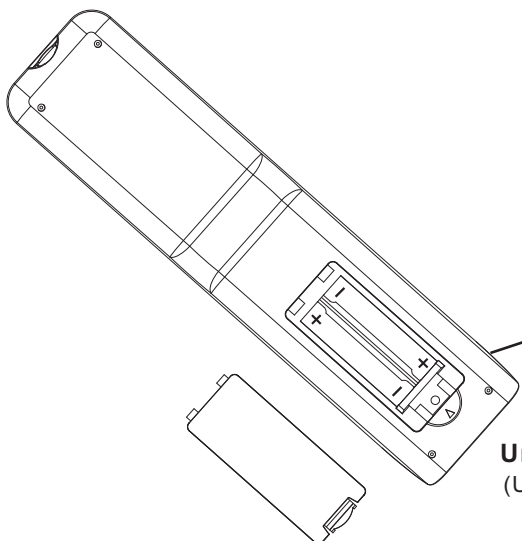

- (1) Open the battery compartment cover on the back side
- (2) Insert two 1.5V batteries of AAA type with correct polarity
- (3) Close the battery compartment cover on the back side

Universal Remote Control code:007F
 (Universal Remote control is not included)

Install and connect TV

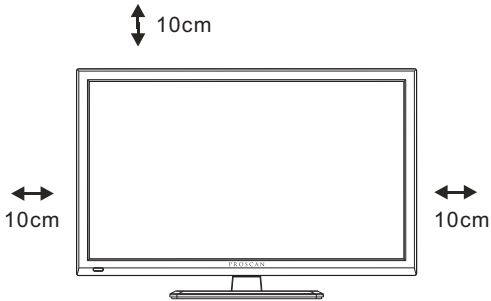

Set your TV

To put your TV in a firm place which can bear the weight of the TV.

To avoid danger, please don't expose the TV near water or heating place (such as light, candle, heating machine), do not block the ventilation at the back of TV.

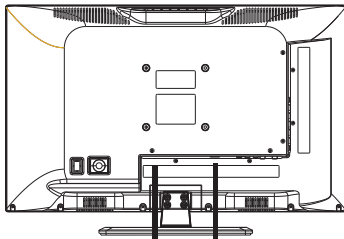

Connect Antenna and power

1. Connect the antenna cable to the antenna socket on the side of the LED TV and the your antenna socket.
2. To plug the power cord of TV

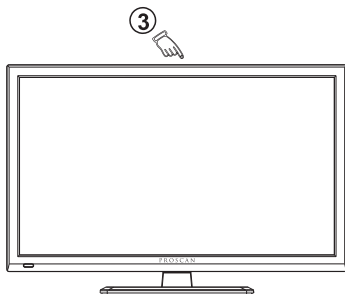

Turn On TV

3. Press the power button of the TV the indication light will turn to green. If the indicator is in standby mode (the light is red), press the power button on the remote control or top of the TV.

NOTE Picture for reference purposes only.

Systems Connection

Note: the first import or export good after connecting cable connecting power.

1.AV INPUT/OUTPUT

Video / Audio input, use the **SOURCE** button select **AV** on the remote control .

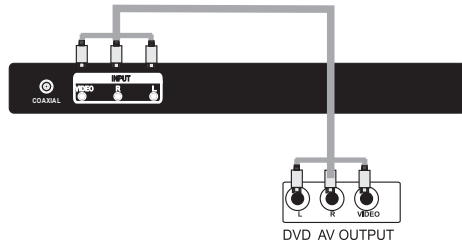

2.Y Pb Pr Input

Y Pb Pr input, use the **SOURCE** button select **Y Pb Pr** on the remote control.

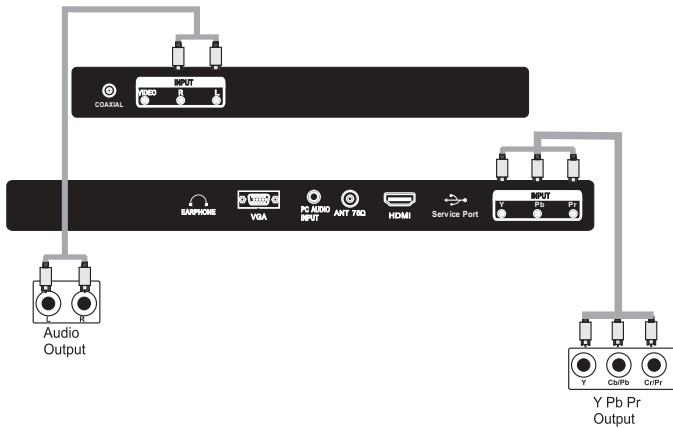

Systems Connection

3.PC INPUT

PC (VGA) input, use the **SOURCE** button select **PC** on the remote control .

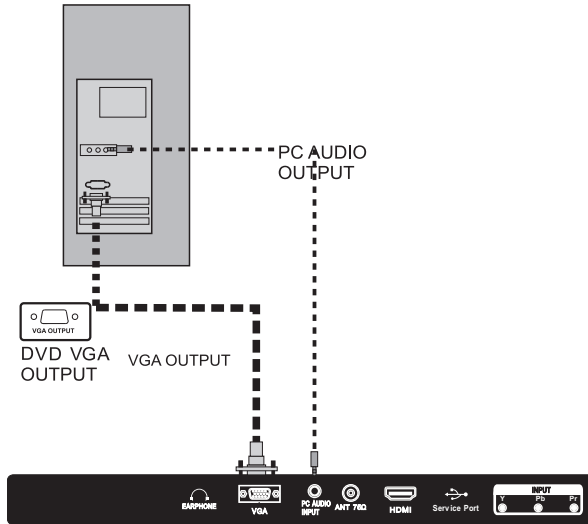

4.HDMI INPUT

HDMI input, use the **SOURCE** button select **HDMI** on the remote control .

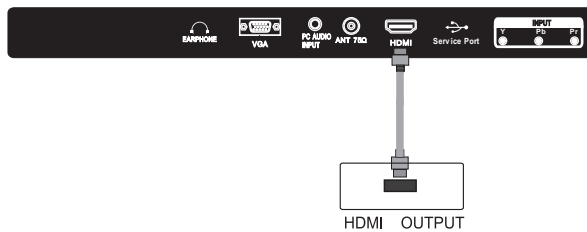

Select Input Source

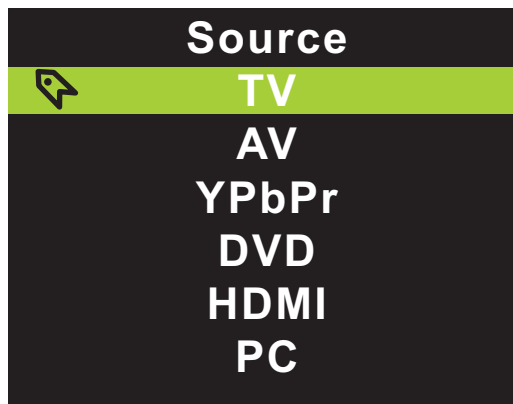

Press **SOURCE** button to display the input source list,

Press ▼ / ▲ or **SOURCE** button to select the input source you want to,

Press **ENTER** button to enter the input source,

Press **EXIT** button to quit.

Main Menu Operation

Picture Menu

Press **MENU** button to display the main menu.

Press **◀ / ▶** button select **PICTURE** in the main menu, then press **ENTER / ▼** to enter.

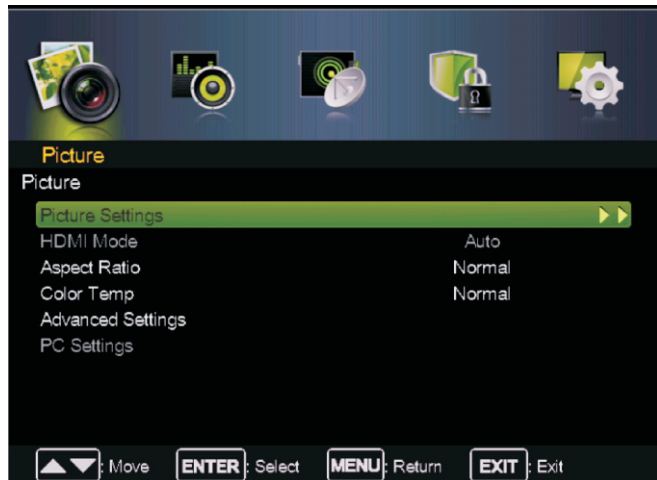

1. Press **▼ / ▲** button to select the option that you want to adjust in the **PICTURE** menu.
2. Press **Enter / ◀ / ▶** button to adjust.
3. After finishing your adjustment, Press **MENU** button to save and return back to the previous menu.

Picture Settings

Press **▼ / ▲** button to select Picture Mode, then press **Enter / ▶** button to enter sub-menu.

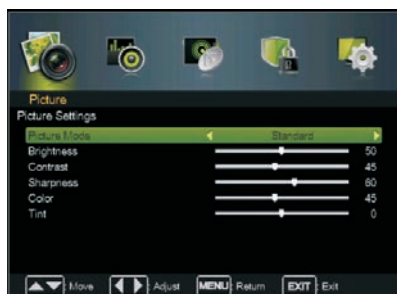

Press **▼ / ▲** button to select Picture Mode, then press **◀ / ▶** button to select.
(Available Picture mode: Standard, Movie, User, Vivid).

TIPS: You can press **P.MODE** button to change the Picture Mode directly.

Main Menu Operation

Brightness/Contrast/ Sharpness/Color/ Tint

Press ▼ / ▲ button to select option, then press ◀ / ▶ button to adjust.

Brightness Adjust the optical fiber output of the entire picture, it will effect the dark region of the picture.

Contrast Adjust the highlight intensity of the picture, but the shadow of the picture is invariable.

Sharpness Adjust the peaking in the detail of the picture.

Color Adjust the saturation of the color based on your own like.

Tint Use in compensating color changed with the transmission in the NTSC code.

HDMI Mode

Press ▼ / ▲ button to select HDMI Mode, then press ◀ / ▶ button to select Auto, Video or PC.

It is available only in **HDMI Input**.

Aspect Ratio

Press ▼ / ▲ button to select Aspect Ratio, then press ◀ / ▶ button to select.

(Available Aspect Ratio: Normal, Wide, Cinema, Zoom).

Normal Automatically adjust Aspect Ratio based on TV size and TV program.

Wide Use to watch wide screen content.

Cinema Stretches image at edges but keeps a clear image in the center.

Zoom Expands image to fill screen. Top and bottom may be cut off.

Color Temp

Change the overall color cast of the picture.

Press ▼ / ▲ button to select Color Temp, then press ◀ / ▶ button to select Normal/Warm/Cool.

Normal Produces a vivid image.

Warm Produces a red-hued image.

Cool Produces a gentle blue-hued image.

Advanced Settings

Adjust advanced video features to fine tune the picture.

Press ▼ / ▲ button to select Advanced Settings, then press **Enter** / ▶ button to enter sub-menu.



Noise Reduction

Set options to reduce video noise.

Press ▼ / ▲ button to select Noise Reduction, then press ◀ / ▶ button to select.

Off Select to turn off video noise detection.

Low Detect and reduce low video noise.

Medium Detect and reduce moderate video noise.

High Detect and reduce enhanced video noise.

Mpeg NR

Set options to reduce MPEG noise.

Press ▼ / ▲ button to select Noise Reduction, then press ◀ / ▶ button to select.

Off Select to turn off MPEG noise detection.

Low Detect and reduce low MPEG noise.

Medium Detect and reduce moderate MPEG noise.

High Detect and reduce enhanced MPEG noise.

Main Menu Operation

Dynamic Contrast

Automatically adjust picture detail and brightness.

Press **▼ / ▲** button to select Dynamic Contrast , then press **◀ / ▶** button to select .

(Available Aspect Ratio: Off,Low,Medium,High).

PC Settings

Press **INPUT** to select PC source.

Press **MENU** to enter the main menu,then press **◀ / ▶** button to select PICTURE menu.

Press **ENTER / ▼** to enter and press **▼** to select PC Settings.



Press **▼ / ▲** button to select PC Settings, then press **◀ / ▶** button to adjust.

Hposition

Adjust the horizontal position of the picture.

Vposition

Adjust the vertical position of the picture.

Phase

Minimize horizontal distortion.

Clock

Minimize vertical stripes in the screen image.

Auto Adjustment

Adjust to the PC signal timing automatically.

Press **MENU / ▶** button to enter.

Main Menu Operation

Audio Menu

Press **MENU** button to display the main menu.

Press **◀ / ▶** button select **AUDIO** in the main menu, then press **ENTER / ▼** to enter.



1. Press **▼ / ▲** button to select the option that you want to adjust in the **AUDIO** menu.

2. Press **Enter / ◀ / ▶** button to adjust.

3. After finishing your adjustment, Press **MENU** button to save and return back to the previous menu.

Audio Mode

Press **▼ / ▲** button to select Audio Mode, then press **Enter / ▶** button to enter sub-menu.

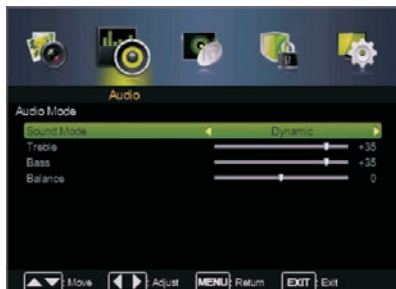

Sound Mode

Press **▼ / ▲** button to select Sound Mode, then press **◀ / ▶** button to select.

(Available Sound mode: Standard, Soft, User, Dynamic).

You can change the value of Treble, Bass and Balance when the sound is in User mode.

TIPS: You can press **SMODE** button on the remote control to change the Sound Mode directly.

Treble/Bass/Balance

Press **▼ / ▲** button to select option, then press **◀ / ▶** button to adjust.

Main Menu Operation

Audio Effect

Press ▼ / ▲ button to select Audio Effect , then press ◀ / ▶ button to select On or Off.

AVL

Set the auto volume control.

Press ▼ / ▲ button to select AVL , then press ◀ / ▶ button to select On or Off.

Analog Language

Configures the multi-track sound. It is only available in ATV.

Press ▼ / ▲ button to select Analog Language , then press ◀ / ▶ button to select Mono,Stereo or Sap.

Mono Sets the sound to mono.

Stereo Sets the sound to stereo when stereo is not available, the sound is automatically switched to mono.

Sap Sets the sound to the second audio program.

Digital Language

Select the language supported by the chosen digital channel. It is available Only in DTV.

Press ▼ / ▲ button to select Digital Language , then press ◀ / ▶ button to select English ,French ,Spanish.

Digital Audio Output

Send the audio output type of coax or optical terminal.

Press ▼ / ▲ button to select Digital Audio Output , then press ◀ / ▶ button to select Off,RAW or PCM.

EQ Settings

Adjust the curve of 7 bands equalizer.

Press ▼ / ▲ button to select EQ Settings, then press **Enter** / ▶ button to enter sub-menu.

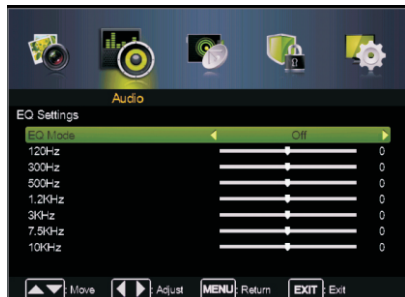

EQ Mode

Press ▼ / ▲ button to select EQ Mode, then press ◀ / ▶ button to select.

(Available EQ mode: Off,Rock,Pop,Jazz,User).

Main Menu Operation

Channel Menu

Press **MENU** button to display the main menu.

Press **◀ / ▶** button to select **CHANNEL** in the main menu, then press **ENTER / ▼** to enter .



1. Press **▼ / ▲** button to select the option that you want to select in the **CHANNEL** menu.
2. Press **Enter** button to enter sub-menu.
3. Press **MENU** button to return back to the previous menu.

Signal Type

Press **▼ / ▲** button to select Signal Type, then press **◀ / ▶** button to select Air or Cable.

Auto Search

Press **▼ / ▲** button to select Auto Search, then press **Enter / ▶** button to start the auto searching.

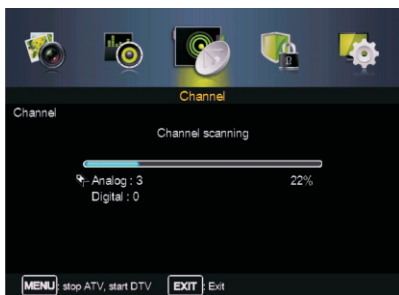

It will search analog channels first, then digital channels.

Before execute auto channel search, please confirm your antenna type is Air or Cable.

Wrong setting of Signal Type maybe cause finding no channel. Found numbers do not include encryption programs.

Main Menu Operation

Channel List

Press **▼ / ▲** button to select Channel List, then press **Enter / ►** button to enter sub-menu. You can view all the channels and choose one quickly.



Press **▼ / ▲** button to highlight a channel and press **ENTER** to view it.

Favorite List

Press **▼ / ▲** button to select Favorite List, then press **Enter / ►** button to enter sub-menu. All of your favorite channels are listed in this menu, and you can choose them quickly.

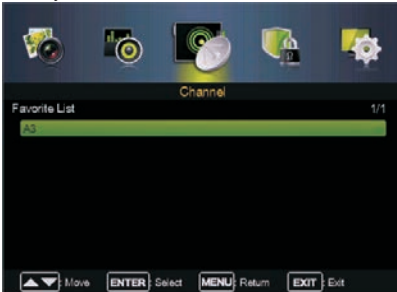

Channel Edit

Press **▼ / ▲** button to select Channel Edit, then press **Enter / ►** button to enter sub-menu.



Skip Set the channel to be skipped when using CH+/CH- to view channels.

Favorite Set the channel to your favorite list.

Press **▼ / ▲** button to select the channel you want to set.

Press **◀ / ▶** button to highlight corresponding item, and press **ENTER** to set or cancel.

Main Menu Operation

Channel Label

Press **▼** / **▲** button to select Channel Label, then press **Enter** / **▶** button to enter sub-menu.



Label Rename label of the channels.

Press **▼** / **▲** button to select the channel and **ENTER** to enter the edit state.

Press **▼** / **▲** button to select the character, press **◀** / **▶** to move the cursor.

Main Menu Operation

Parental Menu

Press **MENU** button to display the main menu.

Press **◀/▶** button select **PARENTAL** in the main menu, then press **ENTER/▼** to enter.

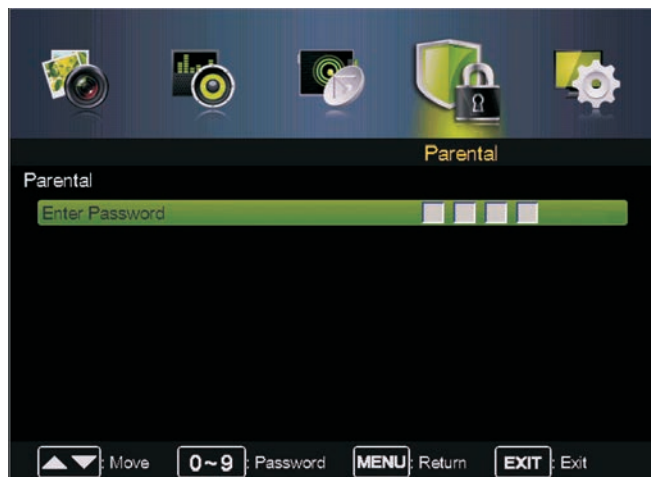

1. Press **▼/▲** button to select the option that you want to adjust in the **PARENTAL** menu.
 2. Press **Enter/◀/▶** button to adjust.
 3. After finishing your adjustment, Press **MENU** button to save and return back to the previous menu.
- Default password is 0000, and if forget what you set, please call the service center.

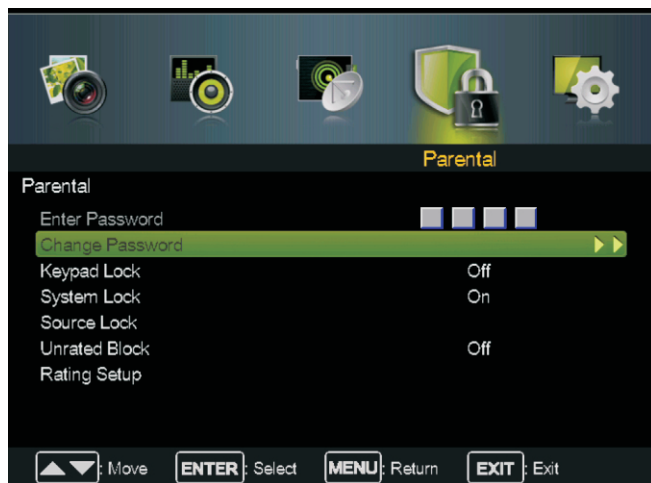

Main Menu Operation

Change Password

Press **▼ / ▲** button to select Change Password, then press **Enter / ►** button to enter sub-menu.



At first you should enter the correct old password, then enter a 4-digital number you want to set twice.

Keypad Lock

Set to prevent it from being used by young children, or other unexpected usage.

Press **▼ / ▲** button to select Keypad Lock, then press **◀ / ▶** button to select On or Off.

System Lock

Set to lock the using of specified source.

Press **▼ / ▲** button to select System Lock, then press **◀ / ▶** button to select On or Off.

Source lock

Press **▼ / ▲** button to select Source lock, then press **Enter / ►** button to enter sub-menu.

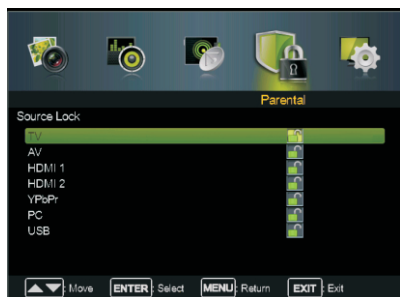

Press **▼ / ▲** button to select Source, then press **ENTER** button to set the Source lock.

Unrated Block

Press **▼ / ▲** button to select Unrated Block, then press **◀ / ▶** button to select On or Off.

Main Menu Operation

Rating Setup

Press **▼** / **▲** button to select Rating Setup, then press **Enter** / **▶** button to enter sub-menu.

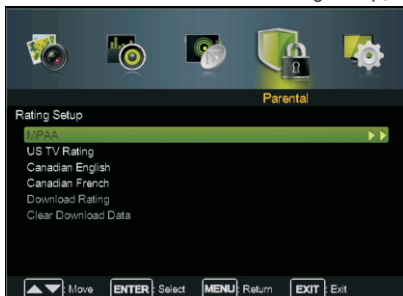

US

For the United States, the rating setting basically include the following options: MPAA,TV.

MPAA

This system defines the rating control which come from MPAA rules.

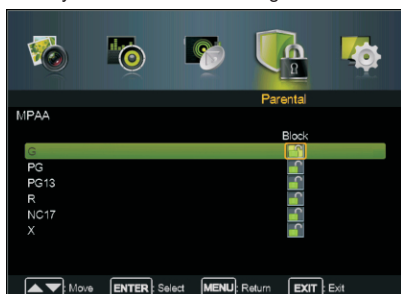

Rating

Define

G	General audience. All ages admitted.
PG	Parental guidance suggested. Some material may not be suitable for children.
PG 13	Parents strongly cautioned. Some material may be inappropriate for children under 13.
R	Restricted. Children under 17 require accompanying parent or adult guardian.
NC 17	No one 17 and under admitted.
X	Adult audience only.

Main Menu Operation

US TV Rating

The TV rating compose of two aspects: age-based and content-based.

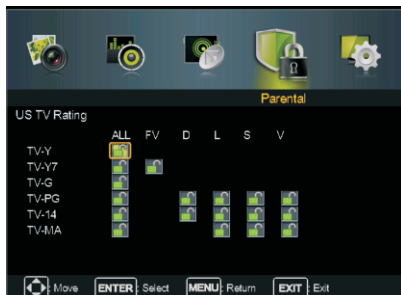

Age	Define	Content	Define
TV-Y	General audience	FV	Fantasy violence
TV-Y7	Parental guidance suggested	D	Suggestive dialogue
TV-G	Parents strongly cautioned	L	Strong language
TV-PG	Retricted	S	Sexual situations
TV-14	No one 17 and under admitted	V	Violence
TV-MA	Adult audience only		

Note: The content ratings will increase depending on the level of the age-based rating. For example, a program with a TV-PG V(violence) rating may contain moderate violence, while a TV-14 V(violence) rating may contain intense violence. So locking a higher level option will automatically cause locking the options that has more sensitive level.

Main Menu Operation

Canada

For Canada, the rating setting include the following options: English Rating, French Rating.

Canadian English

These ratings are for programs which are using English rating system.

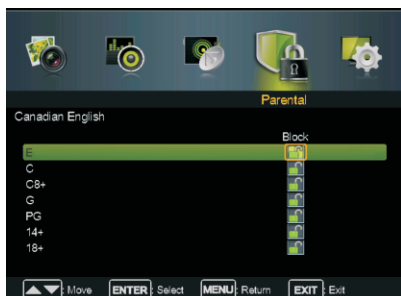

Rating	Defined as
E	No Rating
C	Children
C8+	Children 8 years and older
G	General programming
PG	Parental guidance
14+	Viewers 14 and older
18+	Adult programming

Canadian French

The ratings are for programs which are using French rating system.

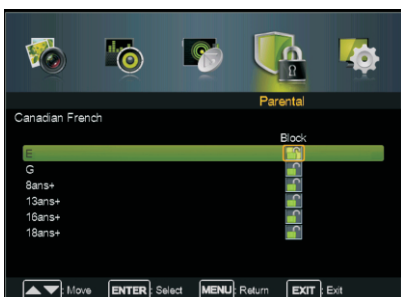

Rating	Defined as
E	No Rating
G	General
8 ans+	Not recommended for younger children
13 ans+	Not recommended for children under age 13
16 ans+	Not recommended for ages under 16
18 ans+	This program is restricted to adults

Download Rating

Control the RRT5 setting which are valid only at some digital cable channels.

Clear Download Data

Select to clear the previous downloadable rating data.

Main Menu Operation

Setup Menu

Press **MENU** button to display the main menu.

Press ◀ / ▶ button select **SETUP** in the main menu, then press **ENTER / ▼** to enter.

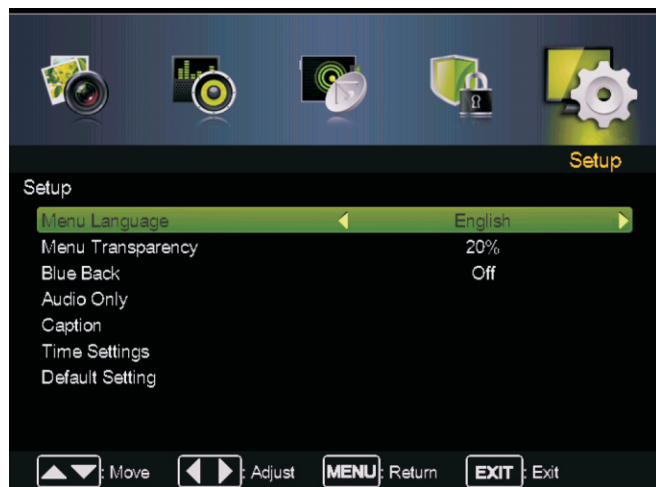

1. Press ▼ / ▲ button to select the option that you want to adjust in the **SETUP** menu.
2. Press **Enter/◀ / ▶** button to adjust.
3. After finishing your adjustment, Press **MENU** button to save and return back to the previous menu.

Menu language

Adjust TV Menu options.

Press ▼ / ▲ button to select Menu language, then press ◀ / ▶ button to select English / Español/ Français .

Menu Transparency

Adjust the transparency of the OSD (on screen display) menu.

Press ▼ / ▲ button to select Menu Transparency, then press ◀ / ▶ button to select.

(Available Menu Transparency: 0%,20%,40%,60%,80%,100%).

Blue Back

Set the screen background color blue or not when no valid signal input. When analog TV input and has no signal, snow noise will display if this option is cleared.

Press ▼ / ▲ button to select Blue Back , then press ◀ / ▶ button to select On or Off.

Audio Only

When you highlight the item, the system will note you that "**Attention! Hold on power key 3 second to restore video**", and if you are sure not need to view (backlight is turned off),

press **No** to confirm. As the attention, if you want to wake up the video, please hold on the power button for 3 seconds.

Main Menu Operation

Caption

Adjust Closed Captioning settings. Only available under TV and AV source.
Press **▼** / **▲** button to select Caption, then press **Enter** / **▶** button to enter sub-menu.

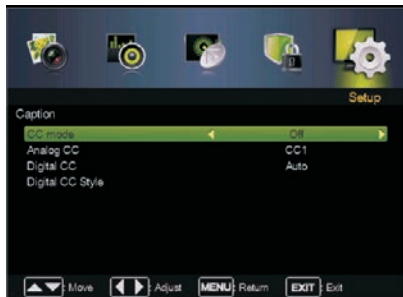

CC Mode

Turn Closed Captioning on/off.
Press **▼** / **▲** button to select CC Mode, then press Off, On or On Mute.

Analog CC

Set Closed Captioning for standard (analog) program.
Press **▼** / **▲** button to select Analog CC, press **◀** / **▶** button to select.
(Available Analog CC: CC1 / CC2 / CC3 / CC4 / TEXT1 / TEXT2 / TEXT3 / TEXT4).
CC1,2,3,4 Displays corresponding caption channel of an analog program.
(Usually be set to CC1 for most programs.)
Text1,2,3,4 Displays corresponding text service channel of an analog program.

Digital CC

Set Closed Captioning for digital program.
Press **▼** / **▲** button to select Digital CC, press **◀** / **▶** button to select.
(Available Digital CC: Auto / Service1 / Service2 / Service3 / Service4 / Service5 / Service6).
Service1,2,3,4,5,6 These are different service data channels.

Digital CC Style

Press **▼** / **▲** button to select Digital CC Style, then press **Enter** / **▶** button to enter sub-menu.

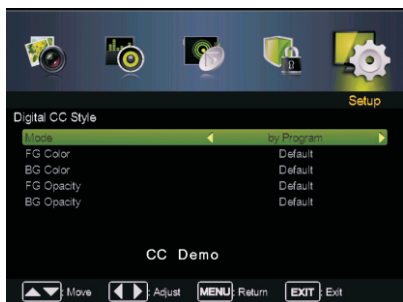

Mode

Set the look of digital Closed Captioning. Automatic uses broadcaster's style.
Press **▼** / **▲** button to select Mode, press **◀** / **▶** button to select by Custom or by Program.
If set to by Custom, Digital CC Style is available.

Main Menu Operation

FG Color

Adjust the color of the digital Closed Captioning font.

Press ▼ / ▲ button to select FG Color,press ◀ / ▶ button to select.

(Available FG Color:by Program, Black ,White , Red , Green , Blue ,Yellow , Cyan, Magenta).

BG Color

Adjust the digital Closed Captioning background color.

Press ▼ / ▲ button to select FG Color,press ◀ / ▶ button to select.

(Available FG Color:by Program, Black ,White , Red , Green , Blue ,Yellow , Cyan, Magenta).

FG Opacity

Adjust the transparency of the digital Closed Captioning font.

Press ▼ / ▲ button to select FG Opacity,press ◀ / ▶ button to select.

(Available FG Opacity:by Program, Solid , Flashing , Translucent, Transparent).

BG Opacity

Adjust the digital Closed Captioning background transparency.

Press ▼ / ▲ button to select BG Opacity,press ◀ / ▶ button to select.

(Available BG Opacity:by Program, Solid , Flashing , Translucent, Transparent).

Time Settings

Press ▼ / ▲ button to select Time Settings, then press **Enter** / ▶ button to enter sub-menu.



OSD Time

Press ▼ / ▲ button to select OSD Time,press ◀ / ▶ button to select.

(Available OSD Time:Off,10sec,20sec,30sec,60sec).

Sleep Time

Set a timer for the TV to turn off automatically.

Press ▼ / ▲ button to select Sleep Time,press ◀ / ▶ button to select.

(Available Sleep Time:Off ,10min, 20min, 30min, 60min, 90min, 120min, 150min, 180min).

Auto Clock

Press ▼ / ▲ button to select Auto Clock ,press ◀ / ▶ button to select On or Off.

If set it to ON , the TV will sync the local clock according to the DTV broadcasting time automatically. Otherwise you can set the time manually.

Time Setup

Set Auto Clock to Off, then you can set the time manually .

Note: In the case of loss of power, the clock setting will be lost.

Time Zone

Select your time zone.

Press ▼ / ▲ button to select Time Zone,press ◀ / ▶ button to select.

(Available Time Zone:Eastern ,Central , Mountain , Pacific , Alaska , Hawaii ,Samoa, Newfoundland ,Atlantic).

Main Menu Operation

Daylight Saving Time

Set the daylight saving time for your area.

Press **▼** / **▲** button to select Daylight Saving Time, press **◀** / **▶** button to select On or Off.

Day of Week

The TV will calculate current day of week according to the time.

Default Setting

Reset TV to factory default.

Press **▼** / **▲** button to select Default Setting, then press **Enter** / **▶** button to enter sub-menu.

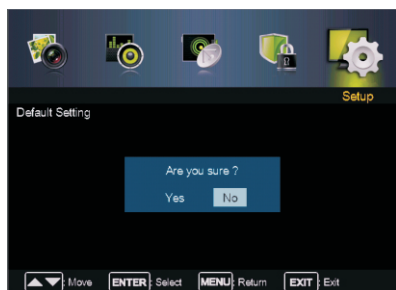

If you are sure to reset, press **Yes** to reset.

DVD Setup

Press the "D.Setup" button to enter the DVD settings menu, use the "◀/▶" buttons to select the desired menu page (General / Audio / Dolby / Video / Preferences), and use "▼/▲" buttons to select the items in each menu, then use "▶" button to enter the selected item. If you then change any setting, press "ENTER" button to confirm the value you changed. Press the "◀" button to return to the left submenu; to go back up to one of the main DVD menu pages, press "EXIT" button.

1. General Setup Page

Osd Language: Set the language of the setup menu and screen display.

Screen saver: Set the screen protection.

Last Memory: Remember and resume from the position of the previous playback.

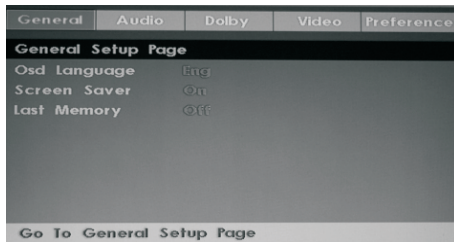

2. Speaker Setup Page

Downmix: This is DVD L/R and stereo output, default as stereo output.

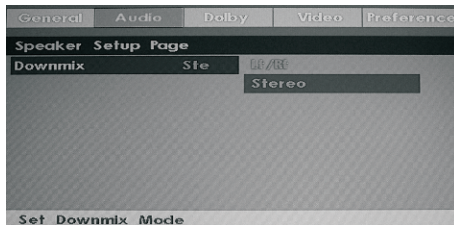

3. Dolby Digital Setup

Dynamic: Adjust sound dynamic range

DVD Setup

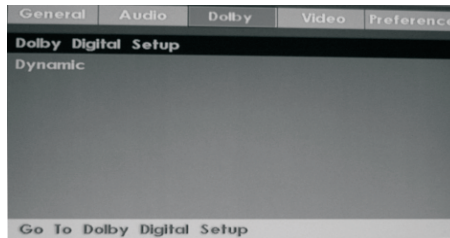

4. Video Setup Page

Sharpness: adjust the sharpness of the image.

Brightness: adjust the brightness of the image.

contrast: adjust the contrast of the image.

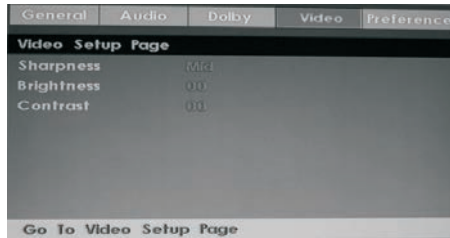

5. Preference Page (Note: This menu page will pop up before put the disc into DVD.)

TV Type: Select the local TV system (PAL TV/Multi/NTSC TV)

Audio: Disc audio language selection (disc dependent)

Subtitle: Disc subtitle language selection (disc dependent)

Disc Menu: Disc Menu language selection (disc dependent)

Parental: Set the maximum disc rating (Kid Safe/G/Pg/Pg 13/Pgr/R/Nc 17/Adult) that can be viewed without a password

(default password is 0000)

Password: Change the password

Default: Choose this to restore the original default Preference settings

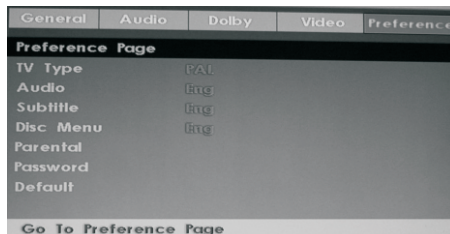

Help

No Power	<ul style="list-style-type: none"> ● Check the plug of LED TV is plug in or not. If still no power, please Pull out the plug and replug in after 60 seconds. And turn on the TV again.
Signal receive not properly	<ul style="list-style-type: none"> ● To cause double image or phantom if there has high building or high mountain round TV. You can adjust image effect by manually operation: consult instruction of vernier regulation or change the direction of external antenna. ● If you use the indoor antenna . under certain circumstance, receive will be more difficult .So you can change the direction of the antenna to adjust the image effect . If can't change image receiving effect either , you have to use external antenna.
No picture	<ul style="list-style-type: none"> ● Check the antenna at the back of LED TV is connected properly or not. ● Try to select other channels and check whether the TV problem itself or not
Video is ok ,but without audio	<ul style="list-style-type: none"> ● Increase the volume. ● Check the TV is in mute mode or not , and please press the mute button to make sound resume.
Audio is ok, but color error or no picture.	<ul style="list-style-type: none"> ● Increase contrast and brightness.
snow statics picture and noise	<ul style="list-style-type: none"> ● Check the antenna at the back of TV is connected or not .
Level broken line	<ul style="list-style-type: none"> ● Maybe has electrical appliance interfere, such as hair drier, vacuum cleaner and so on, please turn off these kinds of electrical appliance.
Dual-Image or "simulacrum" The LED TV no response with the Remote.	<ul style="list-style-type: none"> ● Perhaps the location for the antenna is not good. Use the tall beamed antenna can be improved quality of the display image. ● Operate the remote direct to the remote sensor on the TV. If still no response for the TV, please check if the plastic bag on the remote take or not. And check if the location for the battery is correct. Change the new battery. ● The TV will shift to the STAND BY if no response from the remote in the few minutes.
NO Video In. (PC Mode)	<ul style="list-style-type: none"> ● Please check if the display cable connect to the VGA correcte . ● Please check if there has the bend on the display cable.
Vertical twinkling (PC Mode)	<ul style="list-style-type: none"> ● Enter the main menu. Use the clock regulator for the Video display noise to eliminate the vertical line.
horizontal ripping (PC Mode)	<ul style="list-style-type: none"> ● Adjust the Audio sound horizontal in the main menu to clear the horizontal ripping line.
The screen is too bright or too dark (PC Mode)	<ul style="list-style-type: none"> ● Adjust the contrast ratio or brightness in the main menu.
PC Function no response	<ul style="list-style-type: none"> ● Check the computer setting in the state of compatible display resolution
Ripping line in RCA connecting	<ul style="list-style-type: none"> ● Please use good quality connecting cable.
Problem still exist	<ul style="list-style-type: none"> ● Unplug the power adaptor and wait for 30 seconds then connect. If there is some problem with our TV, do not repair it by yourself, please contact with the customer service center.

Note: There will be complete picture and the brightness will come down if the TV is in the static picture for too long time, So please do not keep the TV in a state of same Menu or same picture that has much difference in brightness and contrast ratio for too long time.

Specifications

VGA

Resolution	640x480	800X600	1024x768	1360x768	1920x1080
Vertical frequency hz	60HZ	60HZ	60HZ	60HZ	60HZ

HDMI

Format	480 i/P	576 i/P	720 P	1080 i/P
Vertical frequency hz	60HZ	50HZ	50HZ/60HZ	50HZ/60HZ

Parameter specification

Screen Size	24"
TV system	NTSC / ATSC
Video system	PAL, NTSC
Preset Channels	1253
Input/Output	IN:TV, AV, YPbPr, PC AUDIO,VGA, HDMI. OUT: COAXIAL,EARPHONE.
Speaker Output	5W+5W
Power requirement	AC 100-240V~ 50/60Hz
Power consumption	48W
Accessories	User's manual Remote controller 2 x AAA Batteries

NOTE:

This user's manual is for reference only .Specifications are subject to change without notice